

OptixPanel™ Standard graphic terminals

FactoryTalk® Optix™ software-based operator panels for visualization and maximum connectivity

Highlights

- Embedded solutions based on FactoryTalk Optix software, the new collaborative, cloud-based platform that offers an unprecedented degree of flexibility, scalability, extensibility and openness for visualization and edge computing applications
- Full industrial interoperability for M2M scenarios and interfacing to MES and ERP systems thanks to native support for the OPC UA protocol, simple two-way communication with cloud infrastructures via MQTT protocol
- Aluminum (ALU) and aluminum True Flat (TF) front panels with resistive touchscreen
- True Flat aluminum and glass front panels (TFM) with multitouch back-projected capacitive touchscreen
- True Flat stainless steel (TFK) front panels with resistive touchscreen
- Available with 10.4", 12.1" and 15" in 4:3 aspect ratio and 7", 10.1", 12.1", 15.6", 18.5" and 21.5" in Wide aspect ratio
- Natively equipped with two Gigabit Ethernet ports, two USB 3.0 ports and a multistandard serial port
- Integrated FactoryTalk® Remote Access™ software for remote assistance (UBIQUITY license compatible)



Allen-Bradley® OptixPanel™ Standard graphic terminals give you a PC-like user experience in a sealed HMI appliance. There is no operating system to secure and smaller applications can benefit from the superior price-performance ratio. They are also available in a wide range of screen sizes, bezel options, aspect ratios and touch screen technologies that support gestures, such as swipe and pinch, and can operate on two independent networks for easier integration on your factory floor.

OptixPanel graphic terminals run FactoryTalk® Optix™ and FactoryTalk® Remote Access™ software, providing flexibility, scalability and enhanced connectivity.



Dimensions

FRONT VIEW

CUT-OUT

SIDE VIEW

OptixPanel Standard - Aluminum - Widescreen

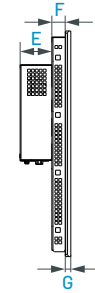
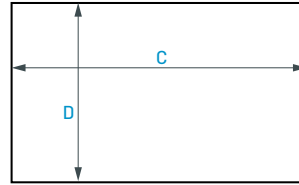
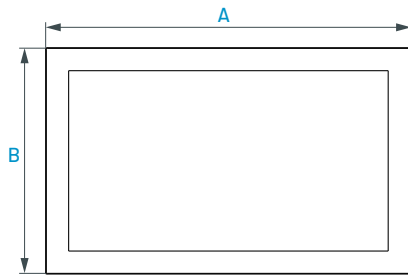

LCD	A		B		C		D		E		F		G	
	mm	in	mm	in	mm	in	mm	in	mm	in	mm	in	mm	in
7"W	207	8.15	150.5	5.93	196	7.72	140	5.51	54	2.13	-	-	5	0.2
10.1"W	269.5	10.61	188	7.40	255.5	10.06	174	6.85	43	1.69	16.8	0.66	5	0.20
12.1"W	315	12.40	217	8.54	301	11.85	203	7.99	43	1.69	19.8	0.78	5	0.20
15.6"W	401.5	15.81	251	9.88	388	15.28	238	9.37	43	1.69	21.8	0.86	5	0.20
18.5"W	467	18.39	288	11.34	453	17.83	274	10.79	43	1.69	19.8	0.78	7	0.28
21.5"W	534	21.02	325.5	12.81	520	20.47	312	12.28	43	1.69	19.8	0.78	7	0.28

OptixPanel Standard - True Flat Multitouch - Widescreen

LCD	A		B		C		D		E		F		G	
	mm	in	mm	in	mm	in	mm	in	mm	in	mm	in	mm	in
7"W	207	8.15	150.5	5.93	196	7.72	140	5.51	54	2.13	-	-	6	0.24
10.1"W	269.5	10.61	188	7.40	255.5	10.06	174	6.85	43	1.69	17.3	0.68	6.5	0.26
12.1"W	315	12.40	217	8.54	301	11.85	203	7.99	43	1.69	20.3	0.80	7.5	0.30
15.6"W	401.5	15.81	251	9.88	388	15.28	238	9.37	43	1.69	22.3	0.88	7.5	0.30
18.5"W	467	18.39	288	11.34	453	17.83	274	10.79	43	1.69	20.3	0.80	10.5	0.41
21.5"W	534	21.02	325.5	12.81	520	20.47	312	12.28	43	1.69	20.3	0.80	10.5	0.41

OptixPanel Standard - Aluminum TrueFlat (4:3) and Aluminum (4:3)

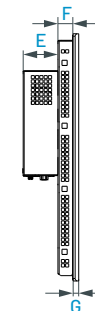
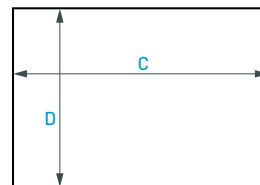
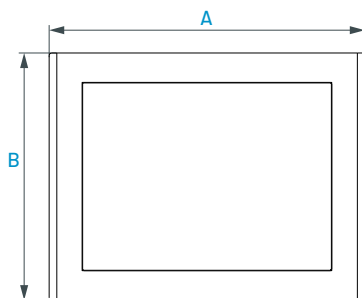

LCD	A		B		C		D		E		F		G	
	mm	in	mm	in	mm	in	mm	in	mm	in	mm	in	mm	in
10.4"	296	11.65	231	9.09	283	11.14	219	8.62	43	1.69	18.8	0.74	6	0.24
12.1"	326	12.83	261	10.28	315	12.40	250	9.84	43	1.69	18.8	0.74	6	0.24
15"	391	15.39	306	12.05	380	14.96	295	11.61	43	1.69	18.8	0.74	7	0.28

Dimensions

FRONT VIEW

CUT-OUT

SIDE VIEW

OptixPanel Standard - Stainless Steel - Widescreen

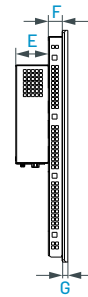
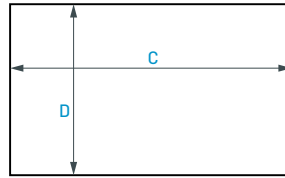
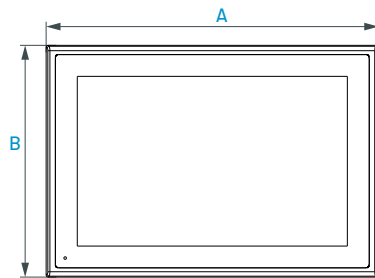

LCD	A		B		C		D		E		F		G	
	mm	in	mm	in	mm	in	mm	in	mm	in	mm	in	mm	in
10.1"W	278.5	10.96	196.5	7.74	255.5	10.06	174	6.85	43	1.69	17.6	0.69	5.3	0.21
12.1"W	324	12.76	226	8.90	301	11.85	203	7.99	43	1.69	20.6	0.81	5.3	0.21
15.6"W	410.5	16.16	260	10.24	388	15.28	238	9.37	43	1.69	23.6	0.93	5.3	0.21
18.5"W	476	18.74	297	11.69	453	17.83	274	10.79	43	1.69	21.6	0.85	5.3	0.21
21.5"W	543.5	21.40	334.5	13.17	520	20.47	312	12.28	43	1.69	21.6	0.85	5.3	0.21

I/O shield

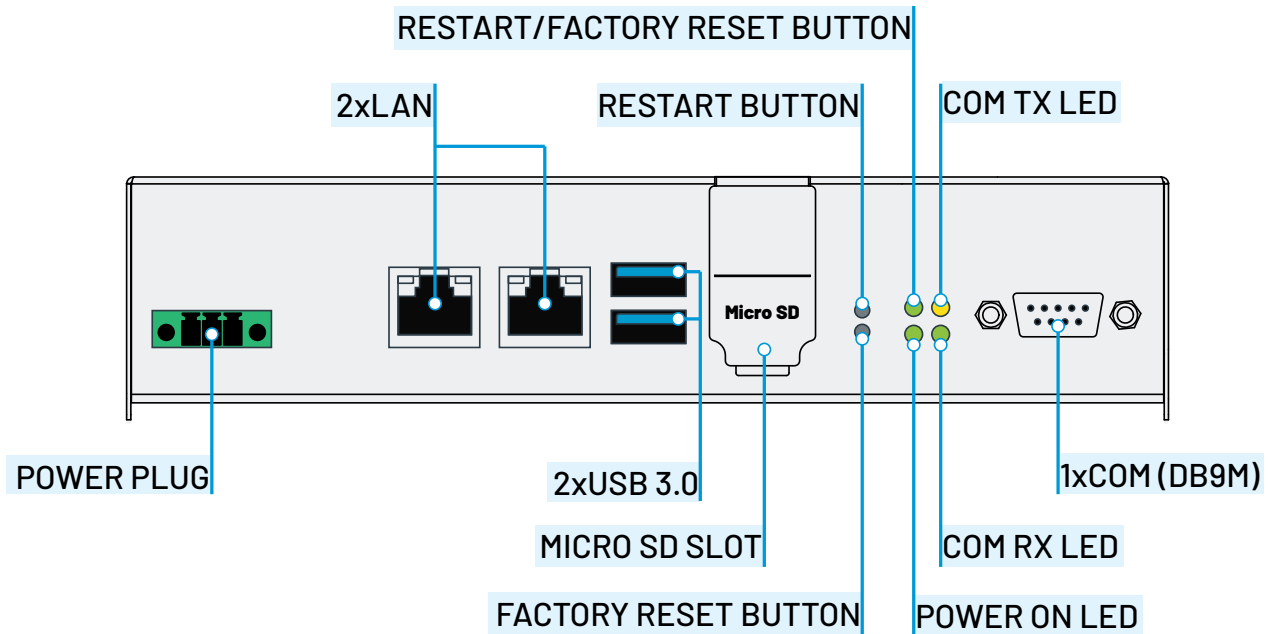

Technical data

	OptixPanel Standard graphic terminals - Aluminum -Widescreen	OptixPanel Standard graphic terminals - Aluminum True Flat (4:3) and Aluminum (4:3)	OptixPanel Standard graphic terminals - True Flat Multitouch - Widescreen	OptixPanel Standard graphic terminals - Stainless Steel - Widescreen
HMI SOFTWARE	FactoryTalk® Optix™ runtime (License size: M / L)			
REMOTE ASSISTANCE SW	FactoryTalk® Remote Access™ PRO (UBIQUITY compatible)			
O.S. INSTALLED	Linux Yocto			
LED BACKLIGHT TFT LCD	7" W - 800x480 10.1" W - 1280x800 12.1" W - 1280x800 15.6" W - 1920x1080 18.5" W - 1920x1080 21.5" W - 1920x1080	10.4" 4:3 - 800x600 12.1" 4:3 - 1024x768 15" 4:3 - 1024x768	7" W - 800x480 10.1" W - 1280x800 12.1" W - 1280x800 15.6" W - 1920x1080 18.5" W - 1920x1080 21.5" W - 1920x1080	10.1" W - 1280x800 12.1" W - 1280x800 15.6" W - 1920x1080 18.5" W - 1920x1080 21.5" W - 1920x1080
TOUCHSCREEN	Resistive 4 wires		P-CAP Multitouch	Resistive 4 wires
FRONT PANEL	Material	Aluminum	True Flat Aluminum	True Flat Stainless Steel
	Logo	A-B or brandless		
PROTECTION GRADE IP	IP rating	IP65 - frontal		IP69K - frontal
	NEMA rating	UL type 1, 4x (indoor only), pending		
CASE	Installation	Panel mounting		
	Material	Zinc-coated skin pass steel		
PROCESSOR (soldered on-board)	NXP i.MX 8M Plus Quad ARM Cortex A53 1.6GHz • 64bit • integrated GPU			
SYSTEM MEMORY RAM	4GB (LP-DDR4 module)			
MASS STORAGE	~12GB eMMC TLC			
STORAGE EXPANSION	1x MicroSD slot on board with external access (push-push)			
INTERFACES	LAN	2x Gigabit Ethernet (RJ45)		
	USB	2x USB 3.0 (Type-A / host)		
	SERIAL	1x RS232/422/485 (DB9M) isolated		
POWER SUPPLY INPUT	24VDC (18 ÷ 32VDC) isolated			
BATTERY	1x BR2032A Internal access			
OPERATING TEMPERATURE	0° ÷ 50°C			
STORAGE TEMPERATURE	-20° ÷ 60°C			
OPERATING/STORAGE RELATIVE HUMIDITY	20% ÷ 90% RH (non-condensing)			
APPROVALS	CE, cULus Listed, UKCA, ATEX, KC, RCM, MOROCCO, ODVA			

Connect with us.    

rockwellautomation.com

expanding human possibility®

AMERICAS: Rockwell Automation, 1201 South Second Street, Milwaukee, WI 53204-2496 USA, Tel: (1) 414.382.2000, Fax: (1) 414.382.4444

EUROPE/MIDDLE EAST/AFRICA: Rockwell Automation NV, Pegasus Park, De Kleetlaan 12a, 1831 Diegem, Belgium, Tel: (32) 2663 0600, Fax: (32) 2 663 0640

ASIA PACIFIC: Rockwell Automation SEA Pte Ltd, 2 Corporation Road, #04-05, Main Lobby, Corporation Place, Singapore 618494, Tel: (65) 6510 6608, FAX: (65) 6510 6699

UNITED KINGDOM: Rockwell Automation Ltd., Pitfield, Kiln Farm, Milton Keynes, MK11 3DR, United Kingdom, Tel: (44)(1908) 838-800, Fax: (44)(1908) 261-917

Allen-Bradley, expanding human possibility, FactoryTalk, FactoryTalk Optix, FactoryTalk Remote Access, OptixPanel, and Rockwell Automation are trademarks of Rockwell Automation, Inc. Trademarks not belonging to Rockwell Automation are property of their respective companies.

Publication 2800S-PP001B-EN-P - August 2024 | Supersedes Publication 2800S-PP001A-EN-P - June 2023

Copyright © 2024 Rockwell Automation, Inc. All Rights Reserved. Printed in USA.